

190 JGE series

Ø190X69mm

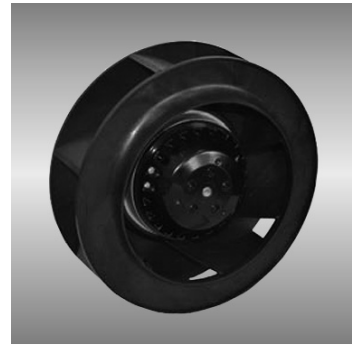

●General Specification / 一般規格

- Motor / Outer rotor induction capacitor motor
 - Material / Frame:Al alloy ; Impeller:PA plastic
 - Insulation / Class B
 - Connection / Wire leads
 - Protection / IP44
 - Bearing / Dual ball bearing
 - Weight / 1.2 Kg
- 馬達 / 外轉電容啟動
 - 材質 / 框：鋁合金；葉：PA 塑膠
 - 絕緣等級 / B
 - 連接 / 導線
 - 保護 / IP44
 - 軸承 / 雙滾珠
 - 重量 / 1.2 Kg

●Specification / 特性

Model 機型	Voltage 電壓	Frequency 頻率	Current 電流	Power 功耗	Speed 轉速	Max. Air Flow 最大風量	Max. Static Pressure 最大風壓	Sound 噪音		
Part No.	V	Hz	A	W	RPM	m ³ /h	CFM	Pa	In-H ₂ O	dBA
JGE19069B2	230	50	0.29	64	2500	570	335	342	1.4	64
JGE19069B2	230	60	0.33	77	2800	620	365	425	1.7	67

● Drawing / 外觀尺寸

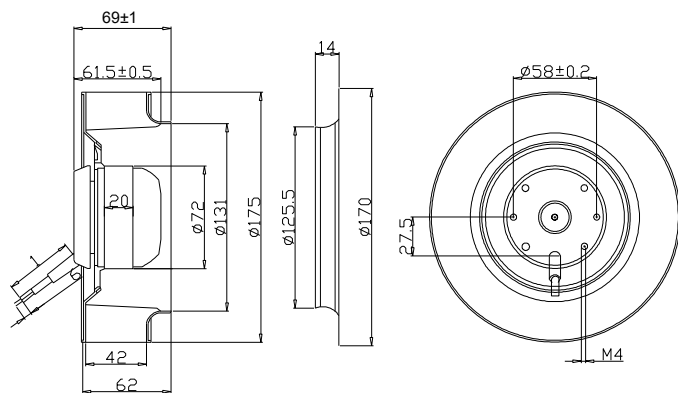

Unit/ 單位 :mm

● Characteristic Curves / P-Q 曲線

